



10th Gen Accord 2.0T Flex Fuel Kit Install Guide



Install Notes: This product requires a red Hondata FlashPro, which is the race version. It will not work with the blue CARB Compliant / Exempt FlashPro.

Installation by a professional is highly recommended unless you are comfortable and experienced in working with fuel lines. When finished with installation, make sure your ECU is seeing the appropriate Ethanol Content Signal. Also, double check for leaks and if any are present do address them immediately, as fuel can easily be ignited by the smallest of sparks given the right conditions.



Emissions Warning: This product is not designed for public highway or street use, and is only legal for formally sanctioned race use on a racing vehicle that may never be used on a public highway or street.

CONTENTS

Parts Overview 3

Harness Overview..... 4

Installation 5

 Under Cover Removal..... 5

 Disconnecting ECT2 Sensor 5

 Fuel Line Replacement and Sensor Installation..... 6

 Chassis Harness Installation 10

 Connecting the Flex Fuel Gauge 11

 Final Checks / Powering-On..... 12

ECU Calibration (Hondata FlashPro)..... 12

 Upload a Hondata Flex Fuel Basemap or Custom Tune 12

Calibrating Ethanol Input Voltage Settings for Hondata (Optional) 12

 Calibrating 'Low Side' (fuel at E15 or lower) 12

 Calibrating 'High Side' (fuel at E65 or higher)..... 13

Calibrating Gauge Output Voltage for KTuner 13

 Connecting to the Innovate Motorsports Gauge 13

 Adjusting Ethanol % Voltage Output 14

Ethanol Mixtures and E85 Info 15

 What is E85? 15

 How Does Ethanol Make More Power? 15

 Is There an Ideal Ethanol Mixture?..... 15

 Where Can I Get E85?..... 16

IMPORTANT SAFETY DISCLAIMER: When working on your car, always follow proper safety procedures. This includes, but is not limited to, letting your car cool down, using the correct tools and protection, jacking/lifting your car correctly, and in general being careful about what you are doing. If you do not feel confident doing something, do not attempt it! Instead, have someone else with more experience try or hire a professional. SiriMoto (and any reseller) cannot be held responsible for any incidental or direct damages, injuries, or additional costs caused by installing any of the parts in this kit.

PARTS OVERVIEW

PART NUMBER	DESCRIPTION/CONTENTS	QUANTITY
SM-HA18-K20-FFIK	10th Gen Accord 2.0T Flex Fuel Installation Kit	1
018-FF-0019	Flex Fuel Hose Assembly – Upper (Long)	1
018-FF-0020	Flex Fuel Hose Assembly – Lower (Short)	1
017-FF-0005	Flex Fuel Chassis Harness	1
015-AL-0015	Mounting Bracket for Flex Fuel Sensor	1
048-EP-0007	SiriMoto Flex Fuel Badge	1
	Zip Tie – 8"	5
3904	MTX-D: Ethanol Gauge (SiriMoto Spec)	1
3907	Ethanol Sensor	1
08-0257	Ethanol Sensor Cable	1
3840	4-Pin Serial Cable	1
2204	Autometer 52mm Gauge Cup	1

HARNESS OVERVIEW

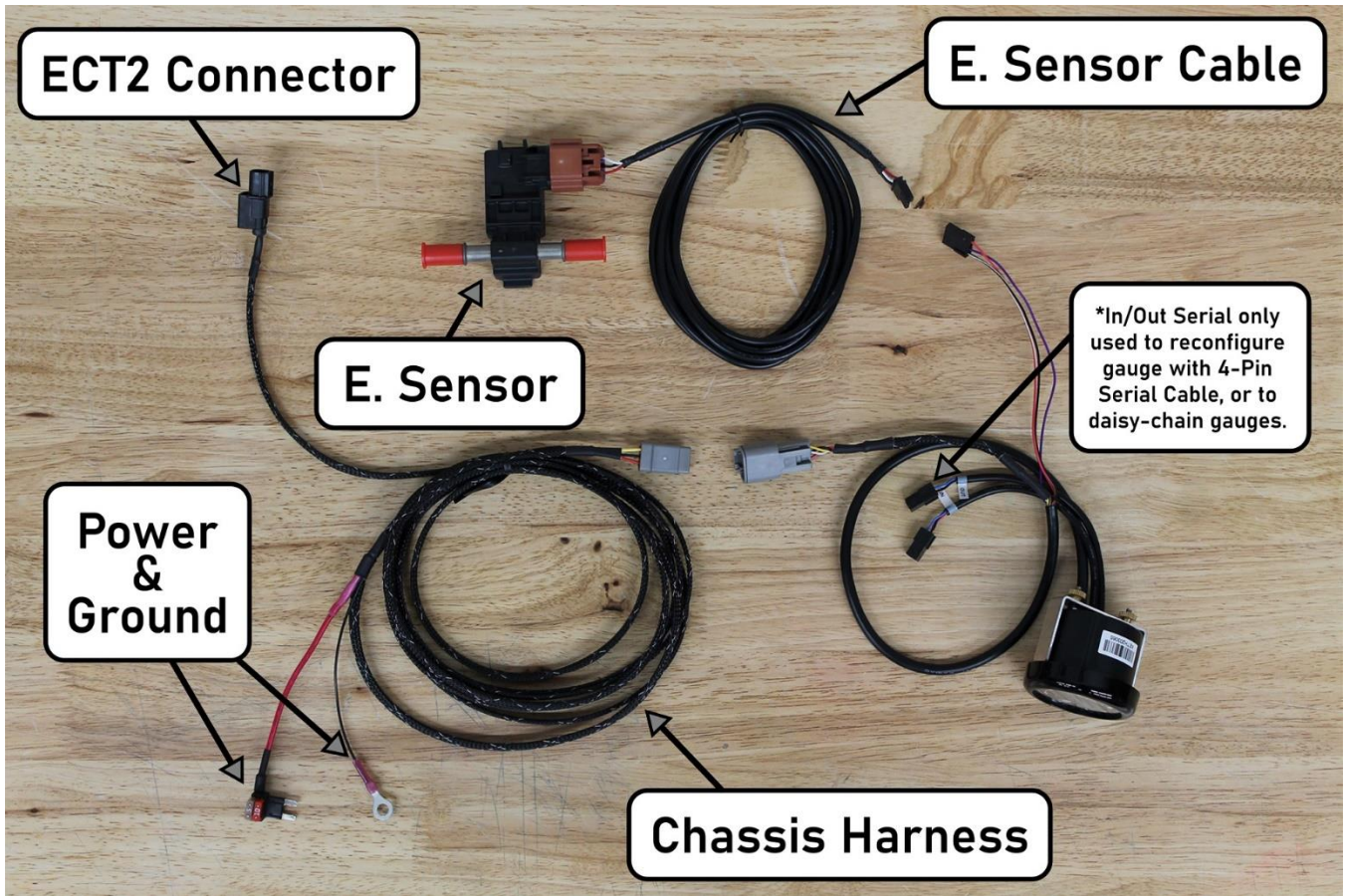

NOTE: 4-Pin Serial Cable (not shown) is not required for the installation of this kit and is only used to reconfigure/update the gauge.

INSTALLATION

UNDER COVER REMOVAL

1. Start by disconnecting the negative battery terminal and then remove the car battery.
2. Securely raise the vehicle with a lift or jack stands and take off the Aluminum Undercover by removing the 7x Slotted Head Fasteners.

DISCONNECTING ECT2 SENSOR

1. Locate the Secondary Engine Coolant Temperature (ECT2) Sensor found at the rear of the radiator near the lower left-hand corner:

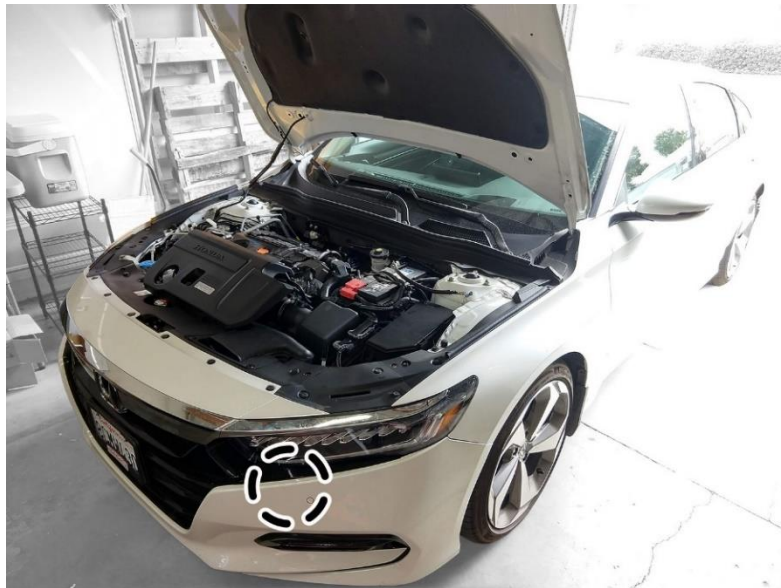

2. Disconnect the vehicle harness connector to the ECT2 Sensor (do not remove the sensor unit from the radiator).



FUEL LINE REPLACEMENT AND SENSOR INSTALLATION

Removal of the factory fuel feed hose and installation of the SiriMoto adapter hoses should be done by a professional/experienced installer. The quick connect fittings are easy to use and the retaining clips do not require any special tool to undo, but the removal/installation must be done with close attention to avoid potential issues.

1. Insert the emergency fuel funnel (A) into the fuel filler neck to relieve the pressure in the fuel tank. *NOTE: The emergency fuel funnel is stored in the trunk toolbox.*



2. Remove the two 10mm Hex Head Bolts (A) holding the fuel hose cover at the firewall.



3. Remove the fuel line/quick-connect fitting cover (if equipped).

4. Check the fuel quick-connect fittings for dirt (clean if needed) and proceed by placing a rag or shop towel over the quick-connect fitting.
5. Hold the connector (A) with one hand and squeeze the retainer tabs (B) with the other hand to release them from the locking tabs (C).

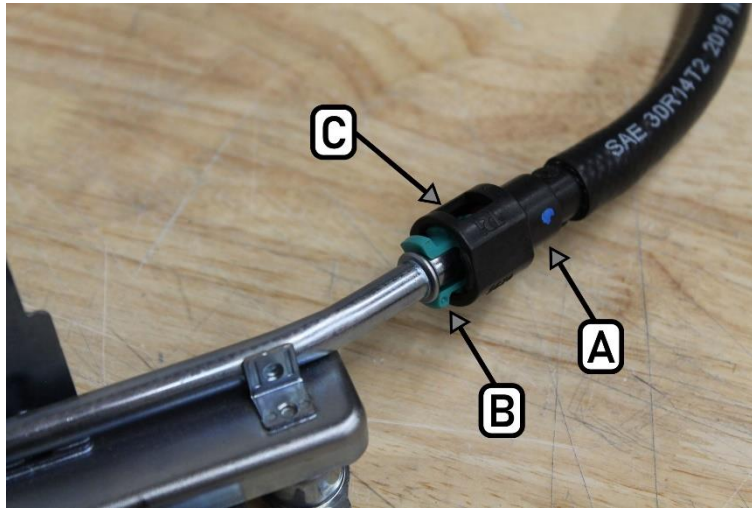

6. Pull the connector (A) and disconnect the fitting.
NOTE:
 - Be careful not to damage the fuel pipe or other parts. Do not use tools.
 - If the connector does not move, keep the retainer tabs pressed down, and alternately pull and push the connector until it comes off easily.
 - Remove the retainer (B) from the fuel pipe.
7. To prevent damage and keep foreign matter out, cover the disconnected pipe end.
8. Remove the Engine Cover by pulling up and releasing the 3x retention grommets.

9. Follow the OEM fuel hose and unfasten the clips holding it to the engine/intake manifold.
10. Repeat Steps 3 through 7 on the end connecting to the engine high pressure pump inlet and remove the hose assembly from the vehicle.
11. Prepare the Ethanol Content Sensor by using one zip tie (A) and mounting it to the sensor bracket as shown.
12. Mount the Sensor and Bracket assembly by using the 10mm Hex Head Bolt for the Hose Bracket found on the Intake Manifold:

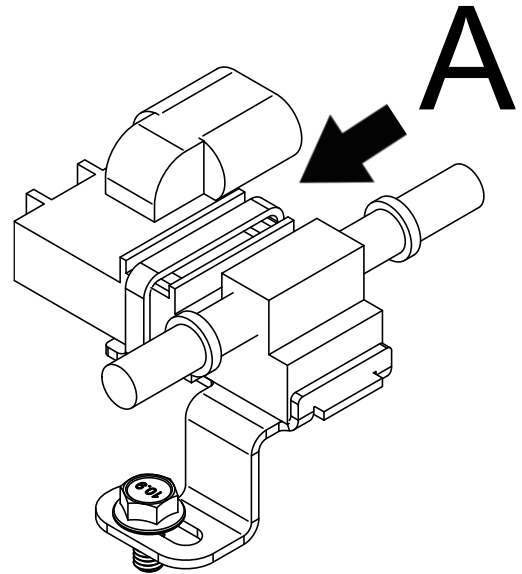

- To do this, simply unscrew the 10mm Hex Head Bolt from the manifold, put the Sensor and Bracket assembly in place and fasten it down with the Hex Head Bolt you removed:



13. Install the longer of the two hose assemblies provided in the kit between the chassis fuel pipe and the Ethanol Content Sensor.



14. Install the shorter of the two hoses from the Ethanol Content Sensor to the inlet on the High Pressure Fuel Pump found on the engine.

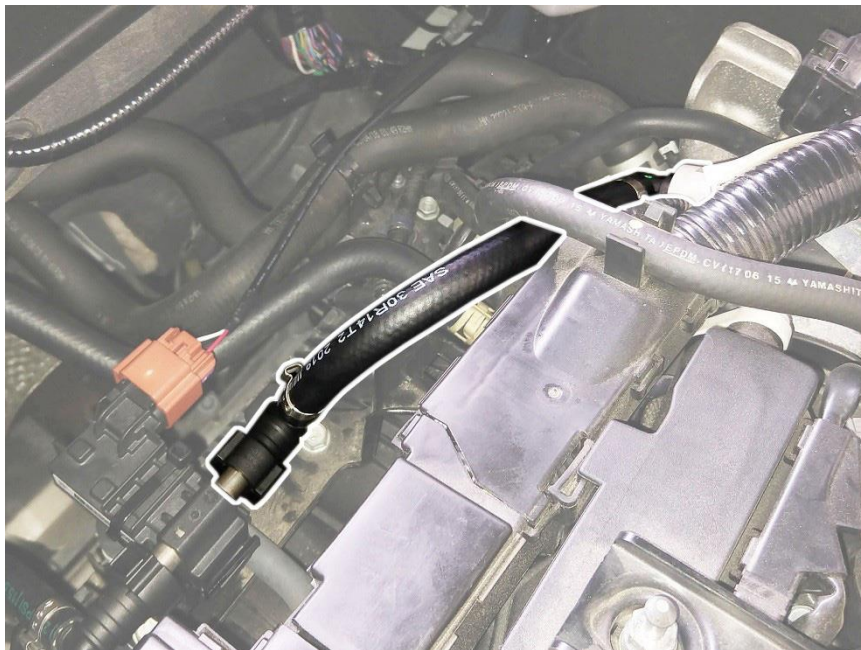

15. Wait to install the engine cover until the entire kit has been installed and the vehicle can run, to check for potential leaks.

CHASSIS HARNESS INSTALLATION

1. Locate the Underdash Fuse Box and find fuse location B45.
2. Connect the SiriMoto Chassis Harness to the B45 fuse location, using the fuse adapter that is attached to the end of the red wire.
3. Fasten the Ring Terminal End of the SiriMoto Chassis Harness to ground. One option is to use the Hex Nut found on the pedal brace/mount. To do this simply remove the hex nut, slide the ring terminal in place and tighten it back up.
4. Route the 3-Pin Grey Connector from the Chassis Harness to the area you will be installing the Ethanol Gauge. It can be tucked away underneath the dash to draw less attention, or it can be mounted with the supplied gauge pod to a number of locations. One good mounting location is on the center console.

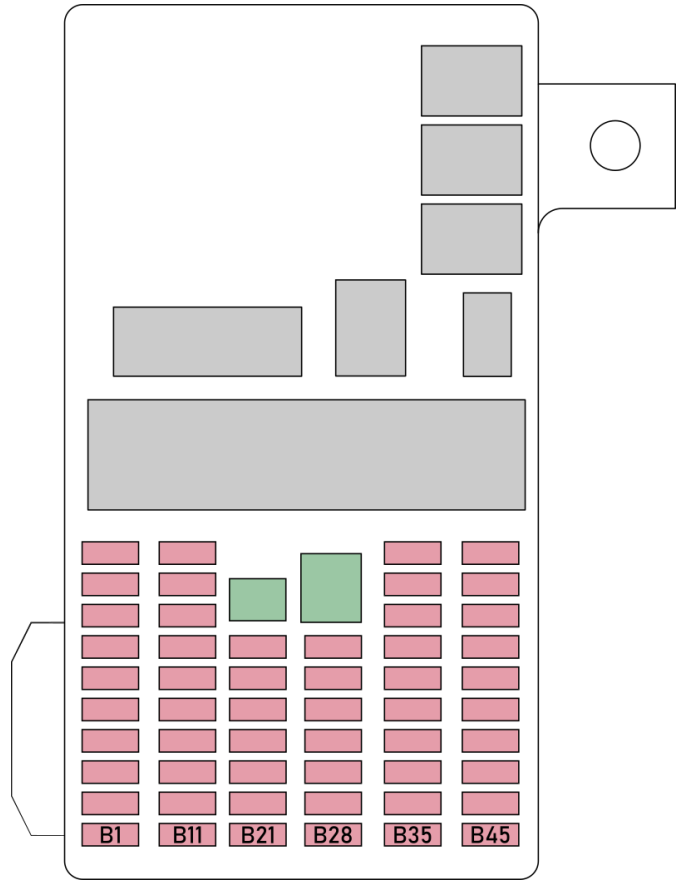

5. Route the Black Male Connector from the Chassis Harness to the engine bay by passing it through the firewall harness grommet, which is located above the throttle pedal assembly.

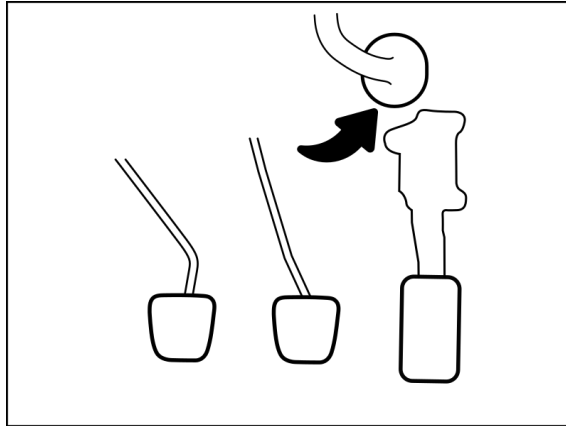

- Carefully cut a small slit while avoiding the OEM harness wiring. *Both the cabin and engine bay side of the grommet must be slit open, in order to pass the harnesses through.*
6. Once the male connector is through the grommet, route it to the ECT2 Sensor location and connect it to the factory harness receptacle that was previously disconnected. When routing it from the grommet to the ECT2 Sensor location, make sure the harness does not come in direct contact with high heat areas or any moving parts.

CONNECTING THE FLEX FUEL GAUGE

1. Start by connecting the Ethanol Sensor Cable to the E. Sensor, and route the black connector to the firewall grommet mentioned previously.
2. Route the harness into the cabin through the grommet, making sure to keep it from coming in direct contact with high heat areas or moving parts.
3. Route both the Chassis Harness and the Ethanol Content Sensor Harness to the gauge location and join each end to its accompanying connector on the Flex Fuel Gauge.
4. Mount/Secure the gauge in its final position and tuck away any excess length of harness.

FINAL CHECKS / POWERING-ON

1. Make sure everything has been properly secured and all connections have been made.
2. Cycle the ignition on ~10 times, BUT DO NOT turn on the engine, in order to prime the fuel system.
3. Double check the gauge is not displaying any errors and is reading properly, along with checking for leaks. *If any errors occur, double check the power, ground and signal wires, and correct any fuel leaks if present.*

ECU CALIBRATION (HONDATA FLASHPRO)

UPLOAD A HONDATA FLEX FUEL BASEMAP OR CUSTOM TUNE

1. At this point you can use your race (red) FlashPro to upload the appropriate calibration for your vehicle. Once the upload is complete, cycle the ignition.
2. With the calibration loaded, you can start your car and enjoy the benefits of the SiriMoto Flex Fuel Kit with E85!
3. Reinstall any remaining parts that were previously removed.

CALIBRATING ETHANOL INPUT VOLTAGE SETTINGS FOR HONDATA (OPTIONAL)

CALIBRATING 'LOW SIDE' (FUEL AT E15 OR LOWER)

1. Turn the car on and connect FlashPro for Live Tuning.
- Ensure Live Tuning is enabled for Ethanol Percentage table.
2. Confirm gauge is displaying E15 or lower in ethanol content.
3. Input gauge display value into the Hondata calibration, for Row 2 Column 1 of Ethanol Percentage vs Volts table.
4. Adjust Input Volts setting, Row 1 Column 1 of Ethanol Percentage table, up or down in value to have the FlashPro Ethanol Content Value match what the gauge is displaying.
5. Save calibration changes, and upload updated file to the car.

CALIBRATING 'HIGH SIDE' (FUEL AT E65 OR HIGHER)

1. Turn the car on and connect FlashPro for 'Live Tuning'.
2. Confirm gauge is displaying E65 or higher in ethanol content.
3. Input gauge display value into the Hondata calibration, for Row 2 Column 2 of Ethanol Percentage vs Volts table.
4. Adjust Input Volts setting, Row 1 Column 2 of Ethanol Percentage table, up or down in value to have the FlashPro Ethanol Content Value match what the gauge is displaying.
5. Save calibration changes, and upload updated file to the car.
 - NOTE: It is possible to follow these same steps at lower ranges (E40 for example) if the car will be used in those lower ethanol percent ranges, as opposed to calibrating the 'High Side' at E65+.

****IMPORTANT**** This general overview is not a complete documented guide on how to tune for ethanol fuel or flex fuel capability. The steps noted are presented as concept and implementation of concept; any change(s) made to a calibration is the responsibility of the installer and end-user.

CALIBRATING GAUGE OUTPUT VOLTAGE FOR KTUNER

CONNECTING TO THE INNOVATE MOTORSPORTS GAUGE

- NOTE: For more complete information, reference the Innovate Motorsports user manual of the MTX-D Ethanol Content Gauge (P/N 3904) which can be found in their support page: <https://www.innovatemotorsports.com/support/>
 1. Download and install the Logworks 3 software package.
 2. Connect the OUT port of the gauge to the provided serial cable and connect the other end to your computer.
 - NOTE: If your computer does not have a serial port you will need to use a Serial to USB adapter, such as Innovate P/N 3733 or similar. In addition, be sure to install the necessary driver(s).
 3. Power up the gauge.
 4. Run the LM Programmer software.

ADJUSTING ETHANOL % VOLTAGE OUTPUT

1. In the LM Programmer window, go to the Ethanol % Output tab.
2. Change the 0% ethanol voltage output value from 0.00 to 0.50.
3. Change the 100% ethanol voltage output value from 5.00 to 4.50.
4. Click the Program button.

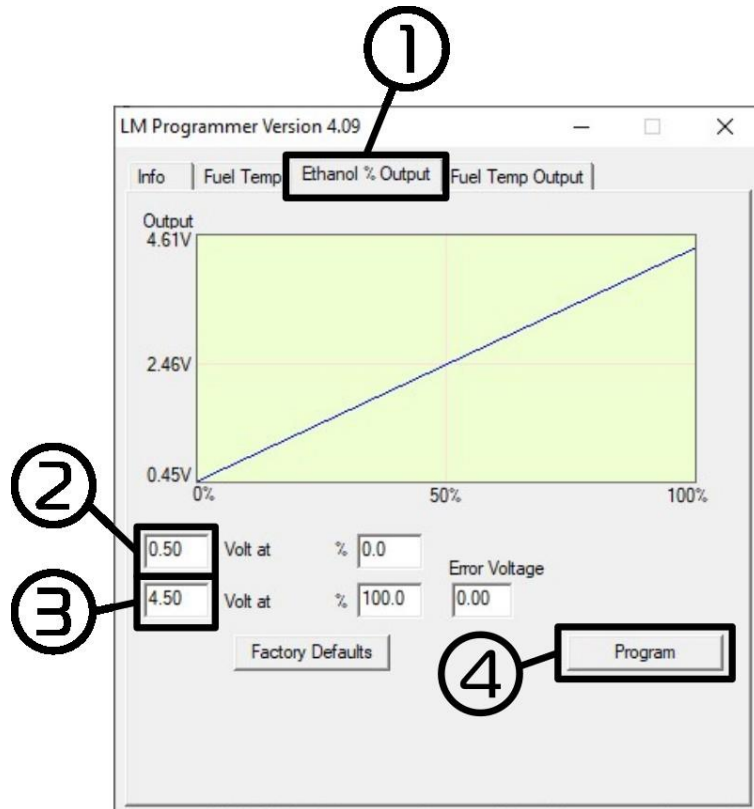

ETHANOL MIXTURES AND E85 INFO

WHAT IS E85?

1. E85 is a biofuel composed of up to 85% ethanol. The remaining 15% of the fuel is traditional gasoline. Keep in mind the ethanol percentage can be lower during the winter months in some areas. The ethanol often is made from corn and is the same type of alcohol you would find in hard liquor, with the exception that fuel ethanol is denatured with additives to make it undesirable and harmful to drink. Although E85 is cheaper to purchase at the pump and has huge performance gains, it does yield lower fuel economy. One nice side effect of that is that extra E85 fuel will help cool your combustion chamber and turbo, and thus help maintain maximum power and reliability.
2. Vehicles sold in the U.S. are designed to operate correctly on the factory tune when using fuel that contains between 10% (E10) and 15% (E15) ethanol. E10 is normally found at almost every standard gas pump in the U.S., so you most likely fill up with it all the time. The reason for this is that ethanol has been found to reduce overall emissions while keeping engine performance strong (see https://afdc.energy.gov/fuels/ethanol_benefits.html for more information).

HOW DOES ETHANOL MAKE MORE POWER?

1. The reason E85 allows for so much more power than traditional gasoline is that it has a very high-octane rating, usually from around 100 to 105 octane compared to 91 to 93 octane from normal gasoline. This high-octane rating allows E85 to resist engine knock. E85 also allows your turbo to spool earlier and faster and causes your engine and turbo to operate considerably cooler and smoother.

IS THERE AN IDEAL ETHANOL MIXTURE?

1. For the Accord's factory fueling system, ~E40 fuel mixtures will generally give you the best combination of power and fuel economy. This applies to the Hondata basemaps and custom tunes.

WHERE CAN I GET E85?

1. The easiest way to find E85 stations is by using websites such as getbiofuel.com or e85prices.com, or phone apps like GasBuddy. Also, E85 blend calculator apps can help you easily achieve your target ethanol blend.

NOTE: A decrease in fuel mileage is to be expected, although normally only by 10% on ~E30 blends and 20~25% on pure E85. Also, it is not recommended to store a vehicle with high concentrations of ethanol fuel in the system. It is best practice to bring the concentration down to about 15% (E15) or lower when storing a car.

Congratulations! Installation of our SiriMoto Flex Fuel Kit is complete, and you can now enjoy the power potential of ethanol fuel.

We believe our SiriMoto kit provides the simplest bolt-in installation and gives enthusiasts the satisfaction of knowing their ethanol fuel mixture without having to turn on an app or use a large screen display.

From the SiriMoto Team, we thank you for choosing this kit, as countless hours were put into the development of this kit along with real-world track testing.

**Best Regards,
TEAM
SIRIMOTO**

